

ViewSonic®

3DV5

3D HD Camcorder

IMPORTANT: Please read this User Guide to obtain important information on installing and using your product in a safe manner, as well as registering your product for future service. Warranty information contained in this User Guide will describe your limited coverage from ViewSonic Corporation, which is also found on our web site at <http://www.viewsonic.com> in English, or in specific languages using the Regional selection box in the upper right corner of our website. "Antes de operar su equipo lea cuidadosamente las instrucciones en este manual"



ViewSonic®

- User Guide
- Guide de l'utilisateur
- Bedienungsanleitung
- Guía del usuario
- Guida dell'utente
- Guia do usuário
- Kullanıcı kılavuzu
- Gebruikshandleiding
- Руководство пользователя
- 使用手冊 (繁體)
- 使用手冊 (簡體)
- 사용자 안내서
- ユーザーガイド
- دليل المستخدم

Model No. : VS13782

Compliance Information

FCC Statement

This device complies with part 15 of FCC Rules. Operation is subject to the following two conditions: (1) this device may not cause harmful interference, and (2) this device must accept any interference received, including interference that may cause undesired operation.

This equipment has been tested and found to comply with the limits for a Class B digital device, pursuant to part 15 of the FCC Rules. These limits are designed to provide reasonable protection against harmful interference in a residential installation. This equipment generates, uses, and can radiate radio frequency energy, and if not installed and used in accordance with the instructions, may cause harmful interference to radio communications. However, there is no guarantee that interference will not occur in a particular installation. If this equipment does cause harmful interference to radio or television reception, which can be determined by turning the equipment off and on, the user is encouraged to try to correct the interference by one or more of the following measures:

- Reorient or relocate the receiving antenna.
- Increase the separation between the equipment and receiver.
- Connect the equipment into an outlet on a circuit different from that to which the receiver is connected.
- Consult the dealer or an experienced radio/TV technician for help.

Warning: You are cautioned that changes or modifications not expressly approved by the party responsible for compliance could void your authority to operate the equipment.

For Canada

- This Class B digital apparatus complies with Canadian ICES-003.
- Cet appareil numérique de la classe B est conforme à la norme NMB-003 du Canada.

CE Conformity for European Countries

 The device complies with the EMC Directive 2004/108/EC and Low Voltage Directive 2006/95/EC.

Following information is only for EU-member states:

The mark is in compliance with the Waste Electrical and Electronic Equipment Directive 2002/96/EC (WEEE).

The mark indicates the requirement NOT to dispose the equipment including any spent or discarded batteries or accumulators as unsorted municipal waste, but use the return and collection systems available.

If the batteries, accumulators and button cells included with this equipment, display the chemical symbol Hg, Cd, or Pb, then it means that the battery has a heavy metal content of more than 0.0005% Mercury or more than, 0.002% Cadmium, or more than 0.004% Lead.



Important Safety Instructions

1. Read these instructions completely before using the equipment.
2. Keep these instructions in a safe place.
3. Heed all warnings.
4. Follow all instructions.
5. Do not use this equipment near water. Warning: To reduce the risk of fire or electric shock, do not expose this apparatus to rain or moisture.
6. Clean with a soft, dry cloth.
7. Do not block any ventilation openings. Install the unit in accordance with the manufacturer's instructions.
8. Do not install near any heat sources such as radiators, heat registers, stoves, or other devices (including amplifiers) that produce heat.
9. Do not defeat the safety purpose of the polarized or grounding-type plug. A polarized plug has two blades with one wider than the other. A grounding type plug has two blades and a third grounding prong. The wide blade and the third prong are provided for your safety. If the provided plug does not fit into your outlet, consult an electrician for replacement of the obsolete outlet.
10. Protect the power cord from being walked on or pinched particularly at plugs. Convenience receptacles and the point where they exit from the unit. Be sure that the power outlet is located near the unit so that it is easily accessible.
11. Only use attachments/accessories specified by the manufacturer.
12. Use only with the cart, stand, tripod, bracket, or table specified by the manufacturer, or sold with the unit. When a cart is used, use caution when moving the cart/unit combination to avoid injury from tipping over.
13. Unplug this unit when unused for long periods of time.
14. Refer all servicing to qualified service personnel. Servicing is required when the unit has been damaged in any way, such as: if the power-supply cord or plug is damaged, if liquid is spilled onto or objects fall into the unit, if the unit is exposed to rain or moisture, or if the unit does not operate normally or has been dropped.
15. Caution: There is a risk of explosion if the battery is replaced by an incorrect type. Dispose of used batteries according to the instructions.
16. Only use battery packs approved by the manufacturer or else damage may occur.



Declaration of RoHS Compliance

This product has been designed and manufactured in compliance with Directive 2002/95/EC of the European Parliament and the Council on restriction of the use of certain hazardous substances in electrical and electronic equipment (RoHS Directive) and is deemed to comply with the maximum concentration values issued by the European Technical Adaptation Committee (TAC) as shown below:

Substance	Proposed Maximum Concentration	Actual Concentration
Lead (Pb)	0.1%	< 0.1%
Mercury (Hg)	0.1%	< 0.1%
Cadmium (Cd)	0.01%	< 0.01%
Hexavalent Chromium (Cr ⁶⁺)	0.1%	< 0.1%
Polybrominated biphenyls (PBB)	0.1%	< 0.1%
Polybrominated diphenyl ethers (PBDE)	0.1%	< 0.1%

Certain components of products as stated above are exempted under the Annex of the RoHS Directives as noted below:

Examples of exempted components are:

1. Mercury in compact fluorescent lamps not exceeding 5 mg per lamp and in other lamps not specifically mentioned in the Annex of RoHS Directive.
2. Lead in glass of cathode ray tubes, electronic components, fluorescent tubes, and electronic ceramic parts (e.g. piezoelectronic devices).
3. Lead in high temperature type solders (i.e. lead-based alloys containing 85% by weight or more lead).
4. Lead as an alloying element in steel containing up to 0.35% lead by weight, aluminium containing up to 0.4% lead by weight and as a copper alloy containing up to 4% lead by weight.

Copyright Information

Copyright © ViewSonic® Corporation, 2010. All rights reserved.

ViewSonic, the three birds logo, OnView, ViewMatch, and ViewMeter are registered trademarks of ViewSonic Corporation.

Disclaimer: ViewSonic Corporation shall not be liable for technical or editorial errors or omissions contained herein; nor for incidental or consequential damages resulting from furnishing this material, or the performance or use of this product.

In the interest of continuing product improvement, ViewSonic Corporation reserves the right to change product specifications without notice. Information in this document may change without notice.

No part of this document may be copied, reproduced, or transmitted by any means, for any purpose without prior written permission from ViewSonic Corporation.

Product Registration

To meet your future needs, and to receive any additional product information as it becomes available, please register your product on the Internet at: www.viewsonic.com. The ViewSonic® Wizard CD-ROM also provides an opportunity for you to print the registration form, which you may mail or fax to ViewSonic.

For Your Records

Product Name:	3DV5 ViewSonic 3D HD Camcorder
Model Number:	VS13782
Document Number:	3DV5_UG_ENG Rev. 1B 11-19-10
Serial Number:	_____
Purchase Date:	_____

Product disposal at end of product life

ViewSonic respects the environment and is committed to working and living green. Thank you for being part of Smarter, Greener Computing. Please visit ViewSonic website to learn more.

USA & Canada: <http://www.viewsonic.com/company/green/recycle-program/>

Europe: <http://www.viewsoniceurope.com/uk/support/recycling-information/>

Taiwan: <http://recycle.epa.gov.tw/recycle/index2.aspx>

Getting Started

Product overview

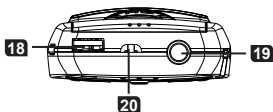
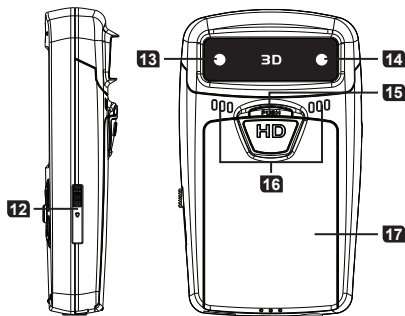
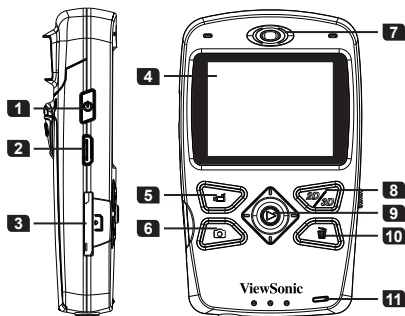

- 1** Power button - Press to turn on; long-press to turn off
- 2** HDMI port
- 3** SD/SDHC card slot
- 4** 2D/3D display
- 5** Record button
- 6** Shutter button
- 7** Speaker
- 8** 2D/3D button - Switch between 2D/3D mode
- 9** 5-way joystick - 5-way: up/down/left/right/enter
Enter: OK or Playback
- 10** Delete button
- 11** Battery charge LED indicator
- 12** USB switch - Slide downwards to use the USB connector
- 13** Right lens - For 2D and 3D capture
- 14** Left lens - For 3D capture
- 15** Push button - For releasing the battery cover
- 16** Microphones
- 17** Battery cover
- 18** USB connector
- 19** Tripod socket
- 20** Hang strap holder

Loading the battery

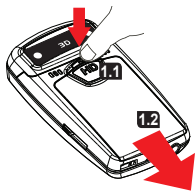

- 1 Press the "PUSH" button, and then pull the battery cover downwards to remove it.

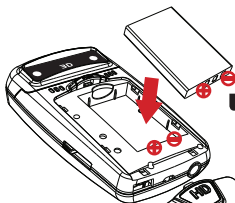

- 2 Place the battery into the compartment. Align the + and - metallic ends carefully.

- 3 Replace the battery cover.

ⓘ Note that the + and - metallic contacts must be aligned with the corresponding contacts in the compartment.

Charging the battery

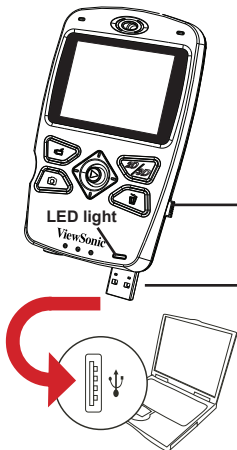

Before charge:

- ⓘ Power off the unit first and make sure the Li-ion battery is installed.
- ⓘ Make sure your PC is powered on during the charge.
- ⓘ It is recommended to charge the battery for at least 8 hours before the first time usage.

- 1 Slide the USB switch downwards to reveal the USB connector.

- 2 Connect the USB connector to a USB port of a powered PC and the charge will begin. Use an extension cable if necessary.

The LED light turns amber when the charge is in progress. After the charge is complete, the LED light will turn green.

Powering on or off / Using a memory card

Press the power button to power on the unit.
Press and hold down for 2 seconds to turn off the unit.

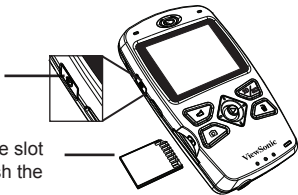

Insert a SD/SDHC card (sold separately) into the slot until it clicks into place. To remove the card, push the card to release it and then pull it out gently.

- i** If the unit cannot be powered on, please check the followings:
- 1) The battery is correctly loaded;
 - 2) The loaded battery has enough power.

Setting language

- 1 Push the Joystick to the right (⇨) to bring up menu.
- 2 Select the “Language” item and Press OK (⏻).
- 3 Move the Joystick up/down (⬆️ / ⬇️) to select your local language. Press the OK button (⏻) to confirm.

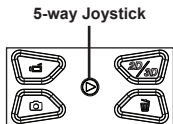

Reading screen icons

Storage:
[Internal Storage Icon]: internal
[Memory Card Icon]: memory card

Preview mode icon

Recording mode:
2D: 2D
3D: 3D

Battery life:
[Full Battery Icon]: full
[Moderate Battery Icon]: moderate
[Low Battery Icon]: low
[Empty Battery Icon]: empty

Zoom bar

Menu button indicator
(Push the joystick to the right to enter the Menu setting)

Remaining recording time



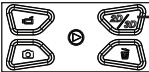

A screenshot of the device's menu screen. The screen is divided into several sections. At the top left, there are two recording mode options: "2D" and "3D". In the top center, there is a "Preview mode icon" showing a camera viewfinder. To the right of the preview mode icon, there are two storage icons: "internal" and "memory card". Below the storage icons is a "Battery life" indicator showing a battery icon with a percentage bar. To the right of the battery indicator is a "Zoom bar" with a green bar and the letters "T" and "W". At the bottom left, there is a "Menu button indicator" showing a joystick icon. At the bottom center, there is a digital display showing "03:27:56". At the bottom right, there is a "Remaining recording time" indicator showing a battery icon with a percentage bar.

Basic Operations

- i**  Press this button to shift between 2D/3D mode. Pressing this button in preview will determine whether the recorded file is 2D or 3D. Pressing this button in playback will let you see the 2D or 3D files stored in your camcorder or memory card. Note that 3D files cannot be recorded/viewed/deleted in 2D mode, and vice versa.

- i** When recording or shooting in 2D mode, only the right lens is used for capturing image.
- i** This product utilizes the “Parallax Barrier” 3D technology. The parallax barrier is a special layer placed in front of the LCD screen. In 3D mode, it allows each of your eye to see a different set of pixels on the screen (hence the 3D effect), and as a result the brightness of the screen will also seem to be halved in 3D mode.

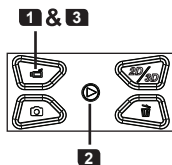

Recording a video clip

- 1** Press the Record button () to start the recording.
- 2** During recording, you can move the Joystick up/down () to zoom in/out the image. You can also press the OK button () to pause or resume the recording.
- 3** Press the Record button () again to stop the recording.



- i** When recording in a dim environment, please use extra light source to illuminate the subject.

Taking a photo

- 1** Move the Joystick up/down () to zoom in/out the image until a proper scene is set.
- 2** Press the Shutter button () to take a photo.

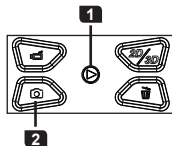

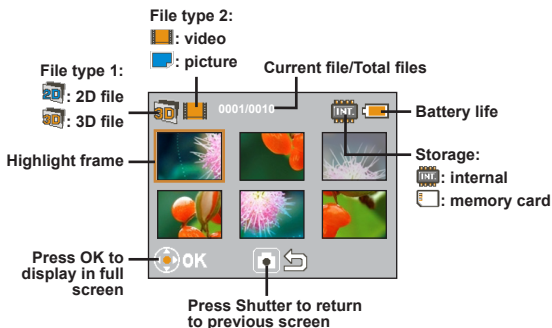

- i** Blurred photos may occur due to hand shake. To avoid blurred photos, please hold the camcorder steady when taking photos or use a tripod to eliminate shaking.

Playback







1 Press the OK button () to enter Playback preview mode.

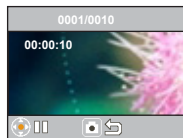





① Press the 2D/3D button () to switch between 2D or 3D files.

2 Use the Joystick () to navigate through your recordings and select a file. Press OK () to view the file in full screen. When a file is viewed in full screen and is not playing or being zoomed and locked, you can move the Joystick left/right () to shift between the previous or next file.





Full screen playback

3-1 When playing a video, you can move the Joystick left/right () to fast rewind or fast forward, or press the OK button () to pause or resume the playback. You can also move the Joystick up/down () to bring up volume control and then left/right () to adjust volume.

3-2 When viewing a photo, you can move the Joystick up/down () to zoom in/out. Press the OK button () to lock ratio and use the Joystick () to browse the photo. To exit the zoomed condition, press OK () and use the Joystick () to zoom out the image until back to normal ratio, or simply press the Shutter () button.

4 To exit Playback mode, press the Shutter () button.





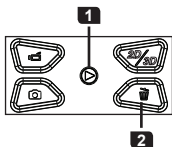

Deleting files

- 1 Press the OK button () to enter Playback mode and use the Joystick () to select a file.
- 2 Press the Delete button () and 3 options will be available:

Option	Description
Yes	Delete the selected file
No	Exit menu without deleting the file
All	Delete all video and image files in the same folder (3D or 2D)



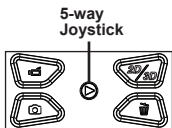

Menu operations

- 1 Push the Joystick to the right () to bring up menu.
- 2 Move the Joystick up/down () to select a menu item and Press OK () to enter.
- 3 Move the Joystick up/down () to select your desired option and press OK () to confirm.
- 4 To exit menu, push the Joystick to the left ().



Menu items

Menu items	Description
Language	Select the language for the Camcorder.
Date & Time	To setup the date and time, move the Joystick up/down () to adjust value; left/right () to shift between fields. Press OK () to save the changes.
Date Stamp	Print a date and time mark on each photo (photo only).
Icon	Enable or disable the icons shown on the display.
Frequency	Set frequency to 50Hz or 60Hz. See the "Frequency table" for more details.

* Frequency table:

Region	England	Germany	France	Italy	Spain	Netherlands	Russia
Setting	50Hz	50Hz	50Hz	50Hz	50Hz	50Hz	50Hz
Region	Portugal	America	Taiwan	China	Japan	Korea	Thailand
Setting	50Hz	60Hz	60Hz	50Hz	50/60Hz	60Hz	50Hz

Note: The Frequency setting is based on the frequency standard of your local power supply.

File management on PC

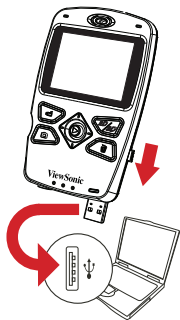

Connect the USB connector of the camcorder to your PC. Power on the camcorder and the LED will turn green. The camcorder is then treated as a removable disk on the PC, allowing you to have access to all files stored in the camcorder.

- ① When you connect the camcorder to your PC for the first time, the installation of the bundled software will automatically start. Please follow the on-screen instructions to complete the software installation.
- ① Copy your normal 2D files into the 2D (DCIM\101DIR2D) folder in your memory card. Do not store 2D files in the 3D (DCIM\100DIR3D) folder, otherwise they will not be detected and displayed.

Connecting to HDTV

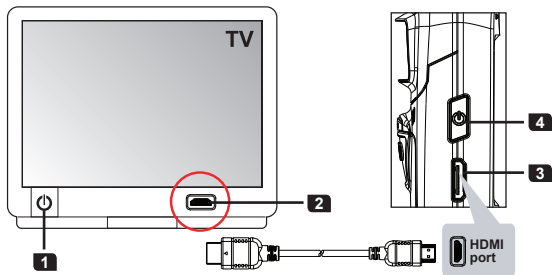

- 1** Turn on your HDTV.
 - 2** Connect the HDMI-in connector (the larger end) of the HDMI cable to the HDTV.
 - 3** Connect the other end of the HDMI cable to your camcorder.
 - 4** Turn on the camcorder.
 - 5** On your HDTV, select the HDMI input port where the HDMI cable is connected.
 - 6** Switch your camcorder to Playback mode and start to play a file. For operation details please refer to the “Playback” section.
- i** If your HDTV is 2D type, the 3D files output on your HDTV will be 2D “side-by-side” only.
- i** If you want to experience 3D effect on your 2D HDTV, you need to convert the 3D files into red/cyan format files by installing and using the bundled software (TotalMedia HD Cam) and copy the converted files into the “DCIM\101DIR2D” folder in the memory card. Then output the playback to your HDTV and wear the red/cyan glasses to watch it. For more information please refer to the “Software Addendum” included in the package.

Using Software

Installing software on your PC

- 1 Connect the camcorder to your PC and power on the camcorder.
- 2 The installation wizard starts. Please wait for the installation wizard to complete the software installation.



- i** After installation, the software installation wizard will not appear the next time you connect the camcorder to your PC.

Playing 3D files on your PC

- 1 Start the TotalMedia HDCam program and enter the main screen.
- i** Select language for the program:
 - 1) Click on “Options” and then select the “Preferences” item.
 - 2) In the pop-up menu, pull down the language menu and select your local language.
 - 3) Click on “OK” and re-start the program for the change to take effect.
- 2 Connect the camcorder to your PC and power on the camcorder. The program will automatically read and display files stored in the camcorder.

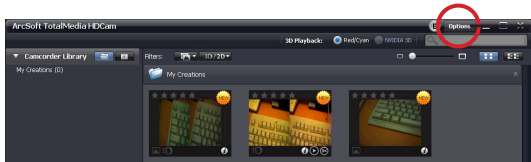

Press here to select language

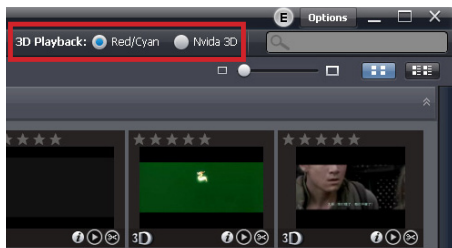

Reading files

- 3** Set the format that you would like to play. If your PC supports the “Nvidia 3D” technology, you can set the option to “Nvidia 3D”. Otherwise you could set to “Red/Cyan”.



- 4** Double-click on a desired file to start playing. You need to wear a pair of 3D glasses (red/cyan or shutter glasses that come with the “Nvidia 3D Kit”) to watch the 3D file.

Uploading videos to Youtube / Facebook

- 1** Select a video file that you want to upload and press the  or  button on the bottom of the software interface. Click on “Next” and the login window will appear.

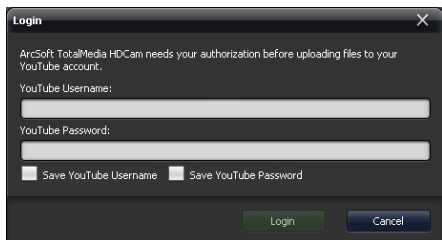

Login to Youtube

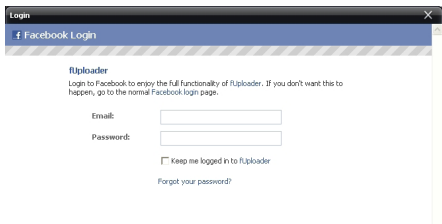

Login to Facebook

2 Enter your account and password, and the video file will be uploaded.

- i** 3D videos uploaded to Youtube can be viewed wearing the red/cyan glasses.
- i** If you want to watch your 3D videos in action on Facebook, you need to convert your 3D files first. Please refer to the “Converting 3D files into 2D red/cyan” section for more information.

Converting 3D files into 2D red/cyan

By converting 3D files into 2D red/cyan files, you can connect the 3D camcorder to a 2D TV with HDMI and watch 3D image with the red/cyan glasses.

- i** In the case that the camcorder is protected for overwriting, please use a card reader for converting files.

1 Press the “Convert to Red/Cyan” button on the bottom of the software interface.



2 Drag the file(s) that you want to convert to the lower task bar. Then click on ‘Next’ and the conversion process will begin. Please save the files into folder: “\DCIM\101DIR2D” of the memory card. The 3D photos will be renamed to PIRCXXXX; the 3D video will be renamed to VIRCXXXX (XXXX is the counting number).

- ⓘ DO NOT save the converted files into the “\DCIM\100DIR3D” folder, otherwise the files will not be played back correctly in red/cyan format.**
- 3** Turn on the camcorder with the memory card inserted and connect to a 2D HDTV via the HDMI cable. Switch to 2D mode first and then enter playback mode by pressing the joystick (). The TV screen becomes dark for a few second before the thumbnails of the files appear on the display.
- 4** Put the red/cyan glasses on, browse the thumbnails in the index, and playback red/cyan converted files.
- ⓘ Facebook does not support 3D files. However, by converting 3D files into red/cyan files, you can upload the converted files to Facebook and watch them with the red/cyan glasses.**

Appendix

Battery life / Capacity table

Battery Life Table	Still picture	Video clip
	Number of shots	Recording time (minute)
	1000	60
	* The unit is set to 3D mode.	

Note: This table is for your reference only. The actual battery life depends on your battery quality and recharge level.

Capacity Table	Memory (SD/SDHC)	Video clip (min.)	Still picture
	2GB	50	1400
	4GB	100	2800
	8GB	200	5600
	16GB	400	11200

Note: The actual value of capacity may vary (up to $\pm 30\%$) depending on the color saturation and complexity of your subject and surroundings.

Troubleshooting

Problem	Possible cause	Solution
I output 3D video/photo playback to my home HDTV. But the 3D effect does not work.	Your TV/display is 2D and therefore does not support the format of the 3D files.	Convert the 3D video/photo into red/cyan format. Then play and output the converted file on your 2D HDTV/display. You also need to wear the accessory red/cyan glasses.
I output 3D video/photo playback to my home 3D HDTV. But the 3D effect does not work.	The system of your 3D TV/display is not correctly set up to support the format of the 3D files.	Select "side-by-side" setting in your 3D HDTV/display to correctly display the 3D effect.
I play my 3D videos/photos on my 3D-featured PC/notebook. But the 3D effect does not work.	The PC/notebook does not support "side-by-side" 3D format or the system is not correctly set up.	1) If your 3D PC/notebook is "Nvidia 3D" compatible, you can set the TotalMedia HDCam program to support "Nvidia 3D" directly. 2) If your PC/notebook is not "Nvidia 3D" compatible, you may consider installing "Nvidia 3D kit" to support the effect. 3) You can download and install the 3D freeware "Stereoscopic Player", and set up the software to support "side-by-side" 3D effect.
Flash occurs when I wear my Shutter Glasses (that comes with 3D HDTV/display) to watch 3D files.	You are watching 3D files under 50Hz or 60Hz fluorescent light.	Turn off the fluorescent light to avoid interference and then watch the 3D files.

Specifications

Item	Specification
Image Sensor	5 Mega-pixels CMOS (2592 x 1944) x 2
Resolution	Camcorder: HD 720p 30f (1280 x 720) Camera: 5M
File Format	MP4 (H.264), JPEG
Video Frame Rate	30 frames per second
Internal Memory	Yes
External Memory	SD card slot (supports 256MB up to 32GB SDHC)
LCD Display	2.4" 3D TFT supports 3D and 2D mode display
3D/2D capture	Yes, switchable
Lens	Fixed focus lens x 2
Focus Range	1 m ~ ∞
Aperture Range	F3.0
Shutter Speed	1 ~ 1/2000 sec.
Digital Zoom	4X
Night Shot Mode	Auto
White Balance	Auto
Exposure Control	Auto
Date Stamp	Yes
Microphone	Yes (Two)
Speaker	Yes
TV out	HDTV (HDMI output)
Auto Power-off	3 minutes
Interface	USB 2.0 mass storage
Battery	NP60 Li-Ion Rechargeable Battery Operating condition: Temperature : 0~45 °C Humidity : 65+- 20% RH
Dimensions (LxWxH)	120 x 72 x 29 mm

Note: Specifications are subject to change without notice.

Customer Support

For technical support or product service, see the table below or contact your reseller.

Note : You will need the product serial number.

Country/Region	Website	T = Telephone F = FAX	Email
Australia/New Zealand	www.viewsonic.com.au	AUS= 1800 880 818 NZ= 0800 008 822	service@au.viewsonic.com
Canada	www.viewsonic.com	T (Toll-Free)= 1-866-463-4775 T (Toll)= 1-424-233-2533 F= 1-909-468-3757	service.ca@viewsonic.com
Europe	www.viewsoniceurope.com	www.viewsoniceurope.com/uk/support/call-desk/	
Hong Kong	www.hk.viewsonic.com	T= 852 3102 2900	service@hk.viewsonic.com
India	www.in.viewsonic.com	T= 1800 11 9999	service@in.viewsonic.com
Ireland (Eire)	www.viewsoniceurope.com/uk/	www.viewsoniceurope.com/ uk/support/call-desk/	service_ie@ viewsoniceurope.com
Korea	www.kr.viewsonic.com	T= 080 333 2131	service@kr.viewsonic.com
Latin America (Argentina)	www.viewsonic.com/la/	T= 0800-4441185	soporte@viewsonic.com
Latin America (Chile)	www.viewsonic.com/la/	T= 1230-020-7975	soporte@viewsonic.com
Latin America (Columbia)	www.viewsonic.com/la/	T= 01800-9-157235	soporte@viewsonic.com
Latin America (Mexico)	www.viewsonic.com/la/	T= 001-8882328722	soporte@viewsonic.com
Renta y Datos, 29 SUR 721, COL. LA PAZ, 72160 PUEBLA, PUE. Tel: 01.222.891.55.77 CON 10 LINEAS Electroser, Av Reforma No. 403Gx39 y 41, 97000 Mérida, Yucatán. Tel: 01.999.925.19.16 Other places please refer to http://www.viewsonic.com/la/soporte/index.htm#Mexico			
Latin America (Peru)	www.viewsonic.com/la/	T= 0800-54565	soporte@viewsonic.com
Macau	www.hk.viewsonic.com	T= 853 2870 0303	service@hk.viewsonic.com
Middle East	ap.viewsonic.com/me/	Contact your reseller	service@ap.viewsonic.com
Puerto Rico & Virgin Islands	www.viewsonic.com	T= 1-800-688-6688 (English) T= 1-866-379-1304 (Spanish) F= 1-909-468-3757	service.us@viewsonic.com soporte@viewsonic.com
Singapore/Malaysia/ Thailand	www.ap.viewsonic.com	T= 65 6461 6044	service@sg.viewsonic.com
South Africa	ap.viewsonic.com/za/	Contact your reseller	service@ap.viewsonic.com
United Kingdom	www.viewsoniceurope.com/uk/	www.viewsoniceurope.com/ uk/support/call-desk/	service_gb@ viewsoniceurope.com
United States	www.viewsonic.com	T (Toll-Free)= 1-800-688-6688 T (Toll)= 1-424-233-2530 F= 1-909-468-3757	service.us@viewsonic.com

Limited Warranty

ViewSonic® 3D HD Camcorder

What the warranty covers:

ViewSonic warrants its products to be free from defects in material and workmanship, under normal use, during the warranty period. If a product proves to be defective in material or workmanship during the warranty period, ViewSonic will, at its sole option, repair or replace the product with a like product. Replacement product or parts may include remanufactured or refurbished parts or components.

How long the warranty is effective:

ViewSonic 3D HD Camcorder are warranted for 1 year for labor from the date of the first customer purchase.

Who the warranty protects:

This warranty is valid only for the first consumer purchaser.

What the warranty does not cover:

1. Any product on which the serial number has been defaced, modified or removed.
2. Damage, deterioration or malfunction resulting from:
 - a. Accident, misuse, neglect, fire, water, lightning, or other acts of nature, unauthorized product modification, or failure to follow instructions supplied with the product.
 - b. Any damage of the product due to shipment.
 - c. Removal or installation of the product.
 - d. Causes external to the product, such as electrical power fluctuations or failure.
 - e. Use of supplies or parts not meeting ViewSonic's specifications.
 - f. Normal wear and tear.
 - g. Any other cause which does not relate to a product defect.
3. Any product exhibiting a condition commonly known as "image burn-in" which results when a static image is displayed on the product for an extended period of time.
4. Removal, installation, one way transportation, insurance, and set-up service charges.

How to get service:

1. For information about receiving service under warranty, contact ViewSonic Customer Support (please refer to Customer Support page). You will need to provide your product's serial number.
2. To obtain warranted service, you will be required to provide (a) the original dated sales slip, (b) your name, (c) your address, (d) a description of the problem, and (e) the serial number of the product.
3. Take or ship the product freight prepaid in the original container to an authorized ViewSonic service center or ViewSonic.
4. For additional information or the name of the nearest ViewSonic service center, contact ViewSonic.

Limitation of implied warranties:

There are no warranties, express or implied, which extend beyond the description contained herein including the implied warranty of merchantability and fitness for a particular purpose.

Exclusion of damages:

ViewSonic's liability is limited to the cost of repair or replacement of the product. ViewSonic shall not be liable for:

1. Damage to other property caused by any defects in the product, damages based upon inconvenience, loss of use of the product, loss of time, loss of profits, loss of business opportunity, loss of goodwill, interference with business relationships, or other commercial loss, even if advised of the possibility of such damages.
2. Any other damages, whether incidental, consequential or otherwise.
3. Any claim against the customer by any other party.
4. Repair or attempted repair by anyone not authorized by ViewSonic.

4.3: ViewSonic 3D HD Camcorder Warranty

3DC_LW01 Rev. 1A 08-05-08

Mexico Limited Warranty

ViewSonic® 3D HD Camcorder

What the warranty covers:

ViewSonic warrants its products to be free from defects in material and workmanship, under normal use, during the warranty period. If a product proves to be defective in material or workmanship during the warranty period, ViewSonic will, at its sole option, repair or replace the product with a like product. Replacement product or parts may include remanufactured or refurbished parts or components.

How long the warranty is effective:

ViewSonic 3D HD Camcorder are warranted for 1 year for labor from the date of the first customer purchase.

Who the warranty protects:

This warranty is valid only for the first consumer purchaser.

What the warranty does not cover:

- Any product on which the serial number has been defaced, modified or removed.
- Damage, deterioration or malfunction resulting from:
 - Accident, misuse, neglect, fire, water, lightning, or other acts of nature, unauthorized product modification, or failure to follow instructions supplied with the product.
 - Any damage of the product due to shipment.
 - Removal or installation of the product.
 - Causes external to the product, such as electrical power fluctuations or failure.
 - Use of supplies or parts not meeting ViewSonic's specifications.
 - Normal wear and tear.
 - Any other cause which does not relate to a product defect.
- Any product exhibiting a condition commonly known as "image burn-in" which results when a static image is displayed on the product for an extended period of time.
- Removal, installation, one way transportation, insurance, and set-up service charges.

How to get service:

For information about receiving service under warranty, contact ViewSonic Customer Support (Please refer to the attached Customer Support page). You will need to provide your product's serial number, so please record the product information in the space provided below on your purchase for your future use. Please retain your receipt of proof of purchase to support your warranty claim.

For Your Records

Product Name: _____ Model Number: _____

Document Number: _____ Serial Number: _____

Purchase Date: _____ Extended Warranty Purchase? _____ (Y/N)

If so, what date does warranty expire? _____

- To obtain warranty service, you will be required to provide (a) the original dated sales slip, (b) your name, (c) your address, (d) a description of the problem, and (e) the serial number of the product.
- Take or ship the product in the original container packaging to an authorized ViewSonic service center.
- Round trip transportation costs for in-warranty products will be paid by ViewSonic.

Limitation of implied warranties:

There are no warranties, express or implied, which extend beyond the description contained herein including the implied warranty of merchantability and fitness for a particular purpose.

Exclusion of damages:

ViewSonic's liability is limited to the cost of repair or replacement of the product. ViewSonic shall not be liable for:

- Damage to other property caused by any defects in the product, damages based upon inconvenience, loss of use of the product, loss of time, loss of profits, loss of business opportunity, loss of goodwill, interference with business relationships, or other commercial loss, even if advised of the possibility of such damages.
- Any other damages, whether incidental, consequential or otherwise.
- Any claim against the customer by any other party.
- Repair or attempted repair by anyone not authorized by ViewSonic.

Contact Information for Sales & Authorized Service (Centro Autorizado de Servicio) within Mexico:	
Name, address, of manufacturer and importers: México, Av. de la Palma #8 Piso 2 Despacho 203, Corporativo Interpalmas, Col. San Fernando Huixquilucan, Estado de México Tel: (55) 3605-1099 http://www.viewsonic.com/la/soporte/index.htm	
NÚMERO GRATIS DE ASISTENCIA TÉCNICA PARA TODO MÉXICO: 001.866.823.2004	
Hermosillo: Distribuciones y Servicios Computacionales SA de CV. Calle Juarez 284 local 2 Col. Bugambillas C.P: 83140 Tel: 01-66-22-14-9005 E-Mail: disc2@hmo.megared.net.mx	Villahermosa: Compumantenimientos Garantizados, S.A. de C.V. AV. GREGORIO MENDEZ #1504 COL, FLORIDA C.P. 86040 Tel: 01 (993) 3 52 00 47 / 3522074 / 3 52 20 09 E-Mail: compumantenimientos@prodigy.net.mx
Puebla, Pue. (Matriz): RENTA Y DATOS, S.A. DE C.V. Domicilio: 29 SUR 721 COL. LA PAZ 72160 PUEBLA, PUE. Tel: 01(52).222.891.55.77 CON 10 LINEAS E-Mail: datos@puebla.megared.net.mx	Veracruz, Ver.: CONEXION Y DESARROLLO, S.A DE C.V. Av. Americas # 419 ENTRE PINZÓN Y ALVARADO Fracc. Reforma C.P. 91919 Tel: 01-22-91-00-31-67 E-Mail: gacosta@qplus.com.mx
Chihuahua Soluciones Globales en Computación C. Magisterio # 3321 Col. Magisterial Chihuahua, Chih. Tel: 4136954 E-Mail: Cefeo@soluglobales.com	Cuernavaca Compusupport de Cuernavaca SA de CV Francisco Leyva # 178 Col. Miguel Hidalgo C.P. 62040, Cuernavaca Morelos Tel: 01 777 3180579 / 01 777 3124014 E-Mail: aquevedo@compusupportcva.com
Distrito Federal: QPLUS, S.A. de C.V. Av. Coyoacán 931 Col. Del Valle 03100, México, D.F. Tel: 01(52)55-50-00-27-35 E-Mail : gacosta@qplus.com.mx	Guadalajara, Jal.: SERVICRECE, S.A. de C.V. Av. Niños Héroes # 2281 Col. Arcos Sur, Sector Juárez 44170, Guadalajara, Jalisco Tel: 01(52)33-36-15-15-43 E-Mail: mmiranda@servicrece.com
Guerrero Acapulco GS Computación (Grupo Sesicomp) Progreso #6-A, Colo Centro 39300 Acapulco, Guerrero Tel: 744-48-32627	Monterrey: Global Product Services Mar Caribe # 1987, Esquina con Golfo Pérsico Fracc. Bernardo Reyes, CP 64280 Monterrey N.L. México Tel: 8129-5103 E-Mail: aydeem@gps1.com.mx
MÉRIDA: ELECTROSER Av Reforma No. 403Gx39 y 41 Mérida, Yucatán, México CP97000 Tel: (52) 999-925-1916 E-Mail: rrb@sureste.com	Oaxaca, Oax.: CENTRO DE DISTRIBUCION Y SERVICIO, S.A. de C.V. Murguía # 708 P.A., Col. Centro, 68000, Oaxaca Tel: 01(52)95-15-15-22-22 Fax: 01(52)95-15-13-67-00 E-Mail: gpotai2001@hotmail.com
Tijuana: STD Av Ferrocarril Sonora #3780 L-C Col 20 de Noviembre Tijuana, Mexico	FOR USA SUPPORT: ViewSonic Corporation 381 Brea Canyon Road, Walnut, CA. 91789 USA Tel: 800-688-6688 (English); 866-323-8056 (Spanish); Fax: 1-800-685-7276 E-Mail: http://www.viewsonic.com



ViewSonic®